

EJOT[®] Iso-Dart

Fastening system for the retrofitting light to medium heavy attachments on ETICS facades.

Product Description

The EJOT Iso-Dart is a fastening system comprising of the following components:

- 1 x plastic installation bush
- 1 x EPDM sealing washer and
- 1 x EJOT facade anchor (Ø 8 mm).

Application area

For retrofitting light to medium heavy attachments to ETICS facades made of EPS, mineral wool and mineral foam.

The recommended load for each fixing point is max. 15 kg (shear force).

Advantages

- High load-bearing capacity through load extension into the substrate
 - Reduced thermal transmission by thermal decoupling
 - **Chi value 0.002 W/K according to TR 025**
 - Waterproofing against the rendered surface with high-quality EPDM seal
 - **Test of the protection against driving rain acc. to DIN EN 12155**
 - Fixing in concrete, solid brick and perforated brick
 - Easy and quick installation
 - Broad application range
- Coarse thread screws Ø 5-6 / Ø 9 mm
Hanger screws Ø 9 mm, M10



Technical Data

Drilling diameter	8 mm
Drilling depth in the substrate	≥ 80 mm
Screw drive	TORX T30

Examples application range

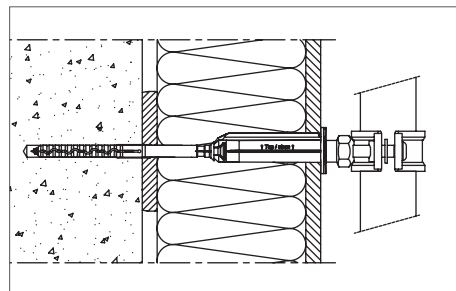

Downpipe clamps

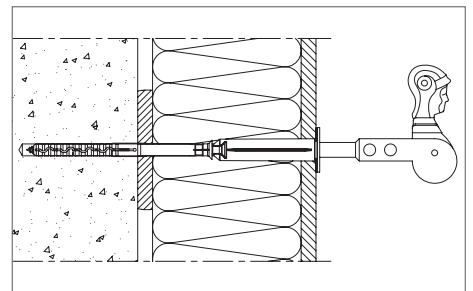

Folding shutter locking mechanism

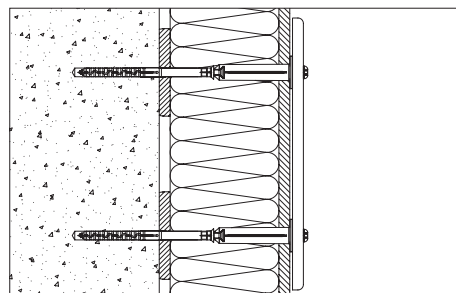

Signs and billboards

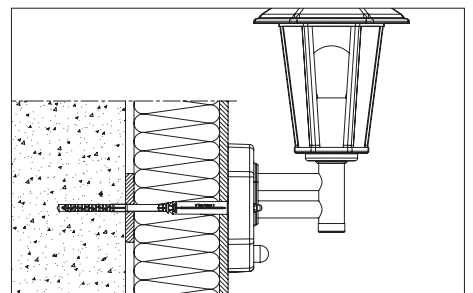

Lights



Learn more on YouTube

Properties

EJOT Iso-Dart for fixing attachments with common \varnothing 9 mm coarse thread screws or \varnothing 9 mm hanger bolts with M10 neck thread.

Minimum installation depth in installation bush:
40 mm

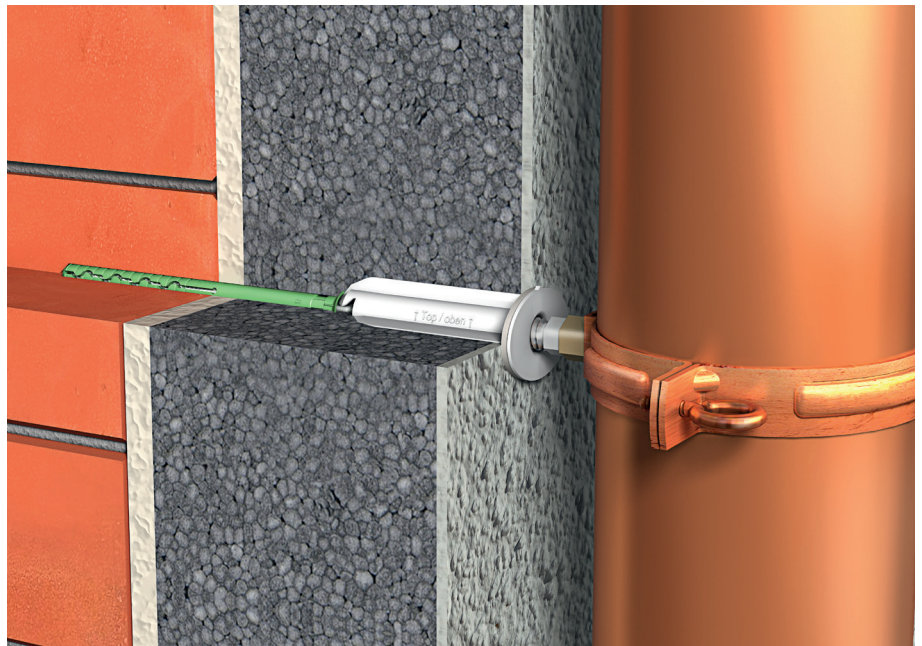

Including an insert, which reduces the internal diameter to accept \varnothing 5 and \varnothing 6 mm coarse thread screws.

Minimum installation depth into insert:
35 mm

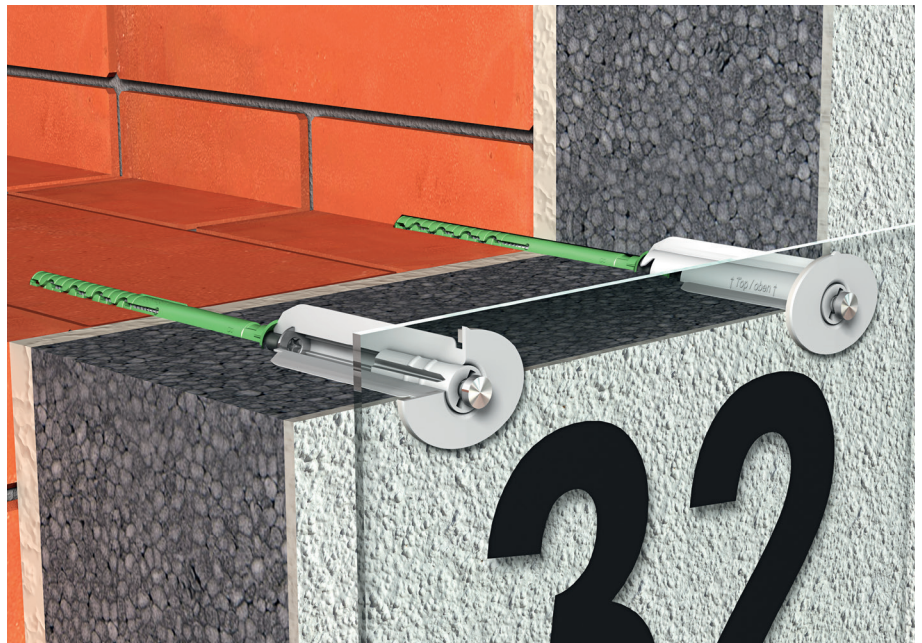

Recommended work loads

Details apply for the shear force transmission immediately after the bush

¹⁾ When using the insert the axial force is limited to max. 0.2 kN

Substrate	Raw density class ρ [kg/dm ³]	Minimum compressive strength f_b [N/mm ²]	Axial tensile strength ¹⁾		Shear force carrying capacity	
			kN	kg	kN	kg
Concrete \geq C12/15	-	-	0.30	30	0.15	15
Solid bricks	≥ 1.8	12	0.30	30	0.15	15
Solid lime sand brick	≥ 1.8	12	0.30	30	0.15	15
Lightweight concrete solid brick	≥ 0.5	4	0.25	25	0.15	15
Vertically perforated bricks	≥ 0.9	12	0.25	25	0.15	15
Perforated lime sand brick	≥ 1.6	12	0.25	25	0.15	15
Lightweight concrete hollow blocks	≥ 0.5	2	0.15	15	0.15	15
Aerated concrete	≥ 0.5	4	0.20	20	0.15	15
Chipboard and OSB boards, d \geq 18 mm	-	-	0.20	20	0.10	10
Solid construction timber (KVH), d \geq 60mm	-	-	0.30	30	0.15	15

Application matrix

¹⁾ Tolerance compensation up to 30 mm

²⁾ Usage of the screw without anchor sleeve
- pre-drill only up to the substrate

Insulation thickness (mm)	Concrete and masonry ¹⁾	Solid timber ²⁾	Composite wood board ²⁾ (OSB, wood chipboard d \geq 18 mm)
80	EJOT Iso-Dart 80	-	-
100	EJOT Iso-Dart 100	-	-
120	EJOT Iso-Dart 120	EJOT Iso-Dart 100	EJOT Iso-Dart 80
140	EJOT Iso-Dart 140	EJOT Iso-Dart 120	EJOT Iso-Dart 100
160	EJOT Iso-Dart 160	EJOT Iso-Dart 140	EJOT Iso-Dart 120
180	EJOT Iso-Dart 180	EJOT Iso-Dart 160	EJOT Iso-Dart 140
200	EJOT Iso-Dart 200	EJOT Iso-Dart 180	EJOT Iso-Dart 160
220	EJOT Iso-Dart 220	EJOT Iso-Dart 200	EJOT Iso-Dart 180
240	EJOT Iso-Dart 240	EJOT Iso-Dart 220	EJOT Iso-Dart 200
260	EJOT Iso-Dart 260	EJOT Iso-Dart 240	EJOT Iso-Dart 220
280	EJOT Iso-Dart 280	EJOT Iso-Dart 260	EJOT Iso-Dart 240
300	-	EJOT Iso-Dart 280	EJOT Iso-Dart 260
320	-	-	EJOT Iso-Dart 280

Delivery scope

EJOT Iso-Dart including

- 1.) 1x EJOT facade anchor
- 2.) 1x installation bush
- 3.) 1x seal
- 4.) 1x reduction insert
- 5.) 1x installation bit

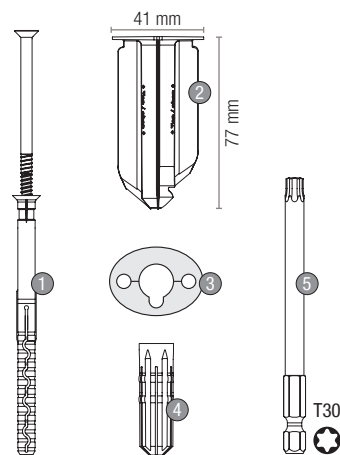

Description	Total length when installed [mm]	Article No.	Qty. / Pack
EJOT Iso-Dart 80	177	8500 080 440	10
EJOT Iso-Dart 100	197	8500 100 440	10
EJOT Iso-Dart 120	217	8500 120 440	10
EJOT Iso-Dart 140	237	8500 140 440	10
EJOT Iso-Dart 160	257	8500 160 440	10
EJOT Iso-Dart 180	277	8500 180 440	10
EJOT Iso-Dart 200	297	8500 200 440	10
EJOT Iso-Dart 220	317	8500 220 440	10
EJOT Iso-Dart 240	337	8500 240 440	10
EJOT Iso-Dart 260	357	8500 260 440	10
EJOT Iso-Dart 280	377	8500 280 440	10

EJOT® Iso-Dart – installation instruction

Fastening system for attachments



Application selection

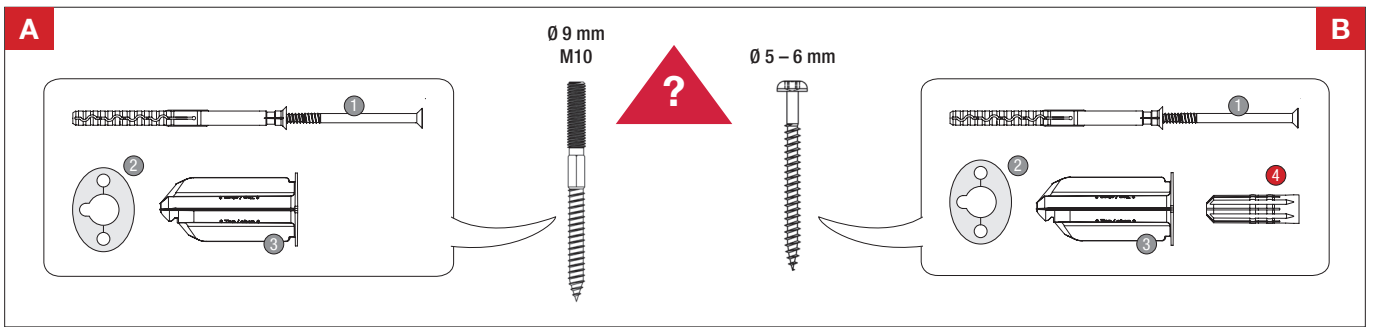

Installation

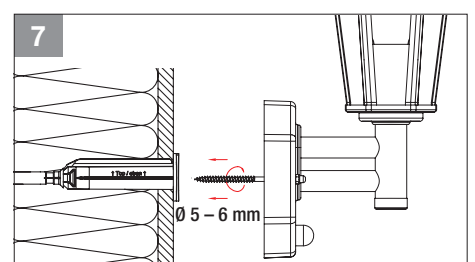
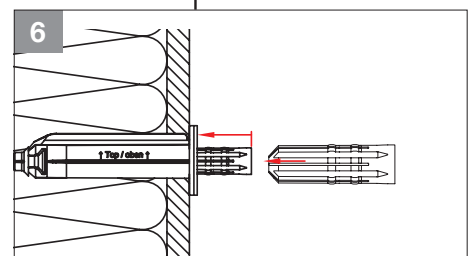
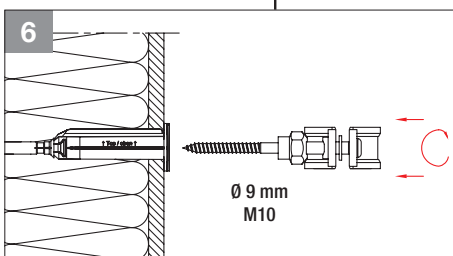
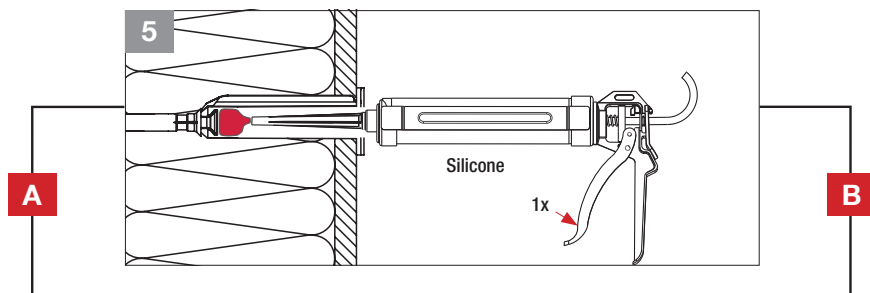
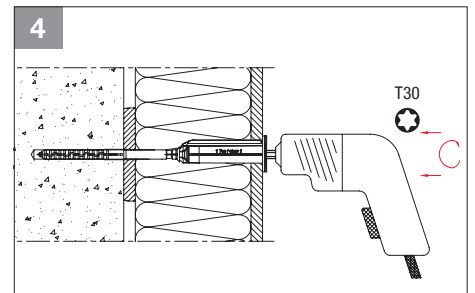
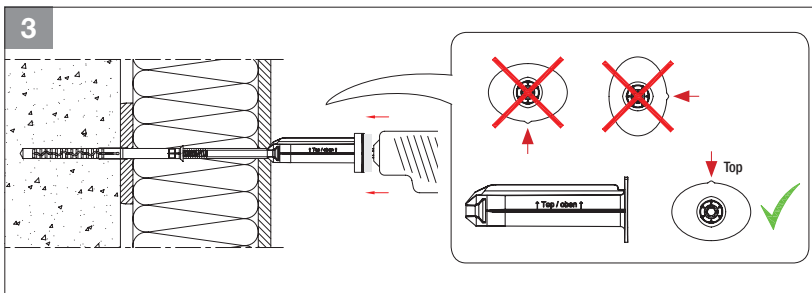
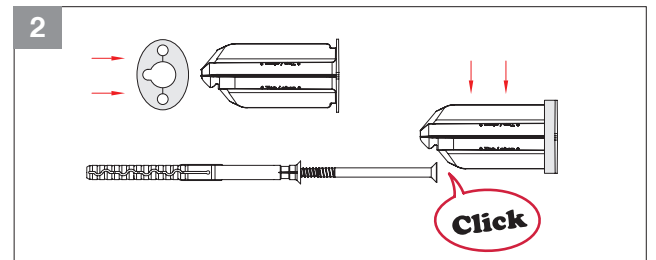
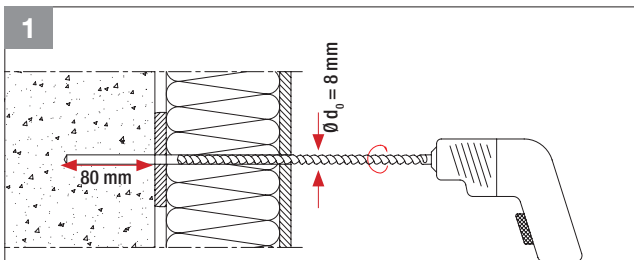

Learn more on YouTube