



EVOPT® screw

The evolution of direct fastening into plastic



... Always a Good Connection



Further information concerning the
EVO PT® screw can be found here!



Globally, the EJOT group of companies specialises in advanced fastening and forming technology. Historically, EJOT customers are mainly from the automotive and supply chain industry, telecommunications and consumer electronics in addition to the building and construction industry.

EJOT's Market Unit Industry offers a wide range of innovative fastening elements, above all self-tapping screws for metals and plastic materials, multifunctional cold-formed components, individual assembly groups made of metal and plastic materials, engineered plastic components as well as special fastening solutions.

Working alongside our customers, EJOT develops individual solutions for their joining applications as well as appropriate assembly parts. The goal is to use "intelligent" products to secure the outstanding quality of the joint and at the same time reduce the overall costs permanently. The savings potential offered by this optimisation approach is much higher compared to the component costs, which are usually only 10 - 20 percent of the total costs.

EJOT - with over 90 years of company history and about 3,500 employees in more than 30 subsidiaries, assures quick global availability of our products and fast, personal contact with our customers.



Evolutionary advantages for your plastic components

The EVO PT® is the evolutionary development of the self-tapping screw for thermoplastics. With this innovative fastening solution, EJOT has successfully combined production and application technology knowledge with new methods based on physical computer simulations for the first time. The result is a screw which sets completely new standards in direct fastening into plastic.

On the pages 10 and 11, you will see what the EVO PT® can achieve for you.

More reliable positioning, high fastening quality

The newly developed "start-of-thread" of the EVO PT® allows for an easy and straight positioning in the screw hole. The special positioning thread thus generates an equal load distribution over the circumference of the thread flanks in installed condition, since the screw is centered automatically in the screw hole during the installation. This ensures a high repeat accuracy and a significantly higher fastening quality.

Further information on the geometric characteristics can be found on pages 6 and 7.

Reduced parts variety, increased economic efficiency

During the installation phase, the innovative forming thread turn creates a torque curve which is virtually independent of the installation depth. This enables smaller installation spaces or a standardisation of screw lengths and tightening torques which directly have an impact on your process chain.

You will see how you can benefit from the EVO PT® effect from page 16 on.

Digital service for optimised components

The digital calculation service EVO CALC® offers you the possibility to pre-calculate the torques and clamp loads as well as the clamp load relaxation under temperature and time. Furthermore, EJOT provides you with an individual, FEM-based component analysis with which you save time and money - beginning with the design of your component.

Further information for an ideal support of your design can be obtained from page 13 on.

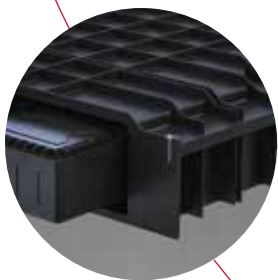

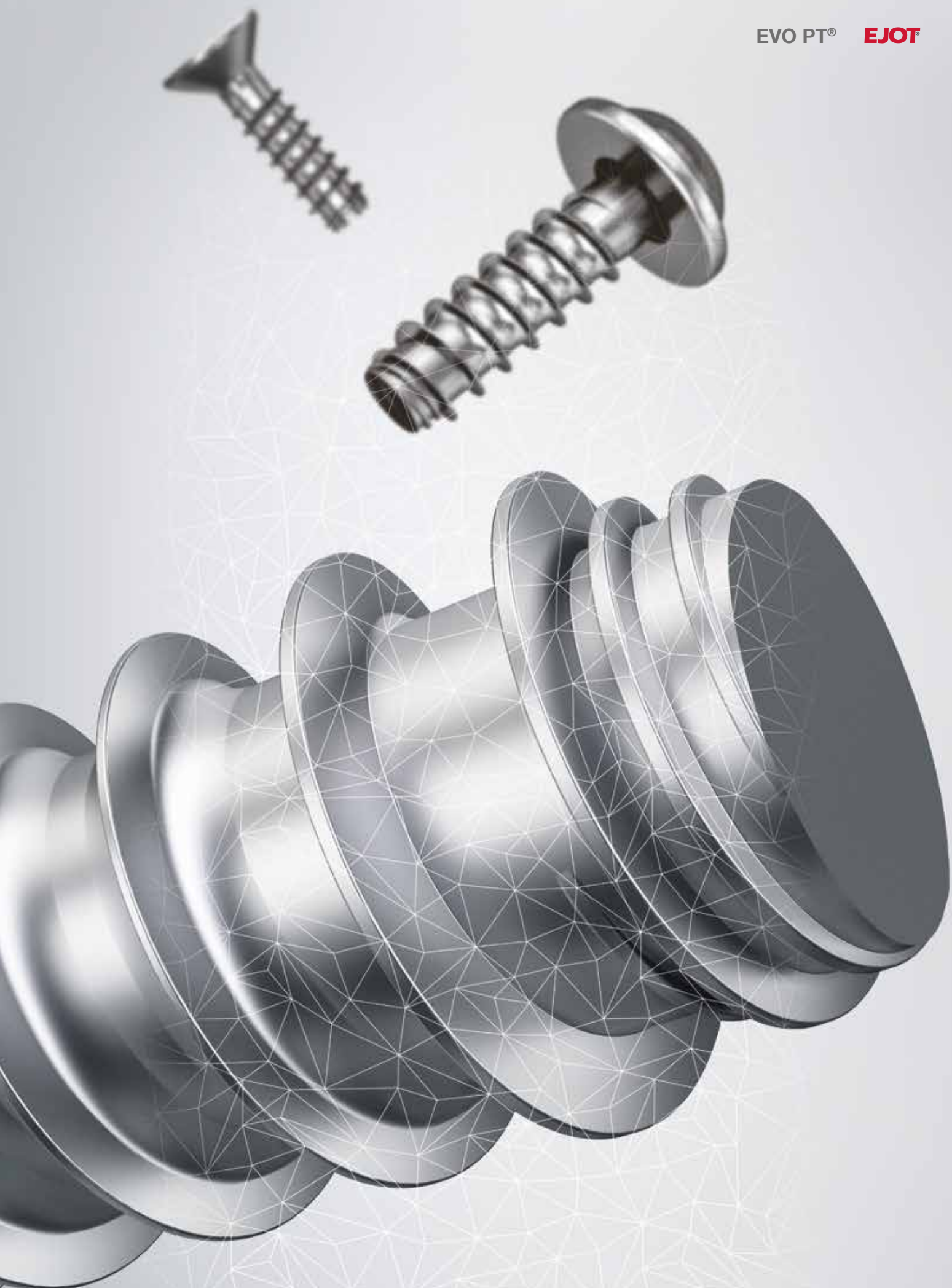

The first intelligent thread!

Characteristics and features of the EVO PT® screw

The EJOT team developed the EVO PT® drawing on vast experience and a genuine passion for fastening technology. Nothing has been left to chance, everything consistently geared to your benefit. The key features at a glance:



Bionic contour

Safety margins for challenging applications

- Higher fatigue strength
- Higher breaking torque
- Higher tensile breaking stress

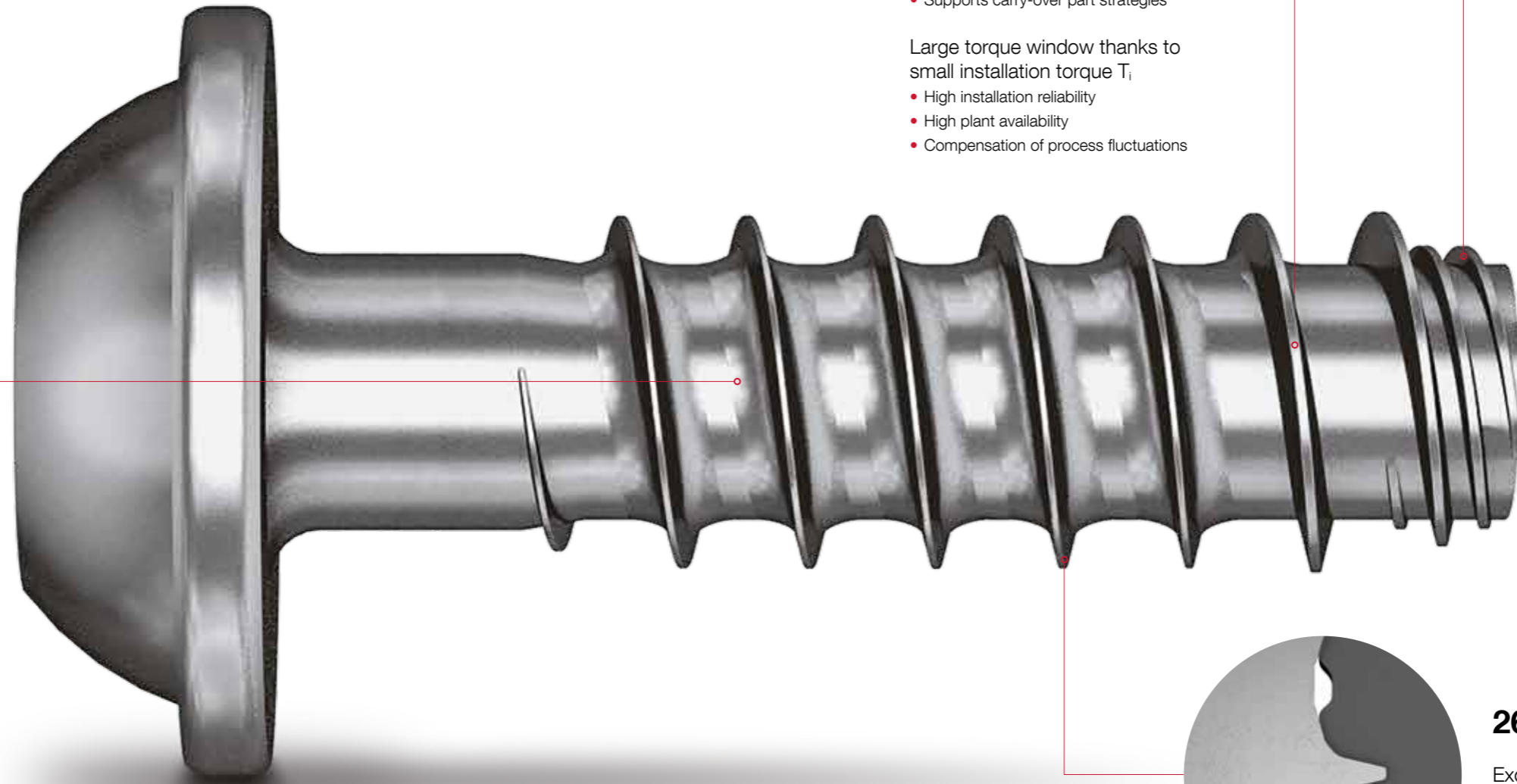

Thread forming zone

Reduced friction during thread forming

- Thread forming torque is virtually independent of the installation depth
- Installation-depth-independent tightening torques
- Reduced parts variety - one screw, one tightening torque per assembly group
- Uniform tube design
- Supports carry-over part strategies

Large torque window thanks to small installation torque T_i

- High installation reliability
- High plant availability
- Compensation of process fluctuations



Lead-in thread

Automatic centring of the screw in the screw hole

- Stable installation process during initial assembly
- Line-integrated, fully automated repeat assembly
- Constant, low-stress surface connection

Smaller counterbore depth

- Less installation space required
- Usage of purchased parts possible without unloading

Automatic compensation in case of axial misalignment (screw/screw hole)

- Compensation of component tolerances

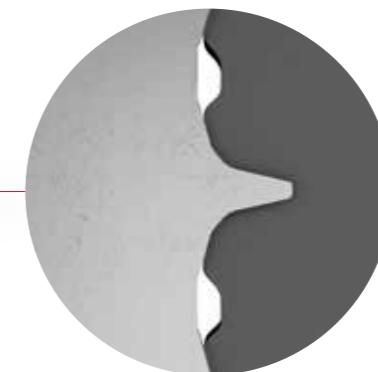

26° flank angle

Excellent plastic forming

- One flank geometry, suitable for all common thermoplastics
- Reduced radial load in the component

Constant torque over the installation depth

Installation of the EVO PT®

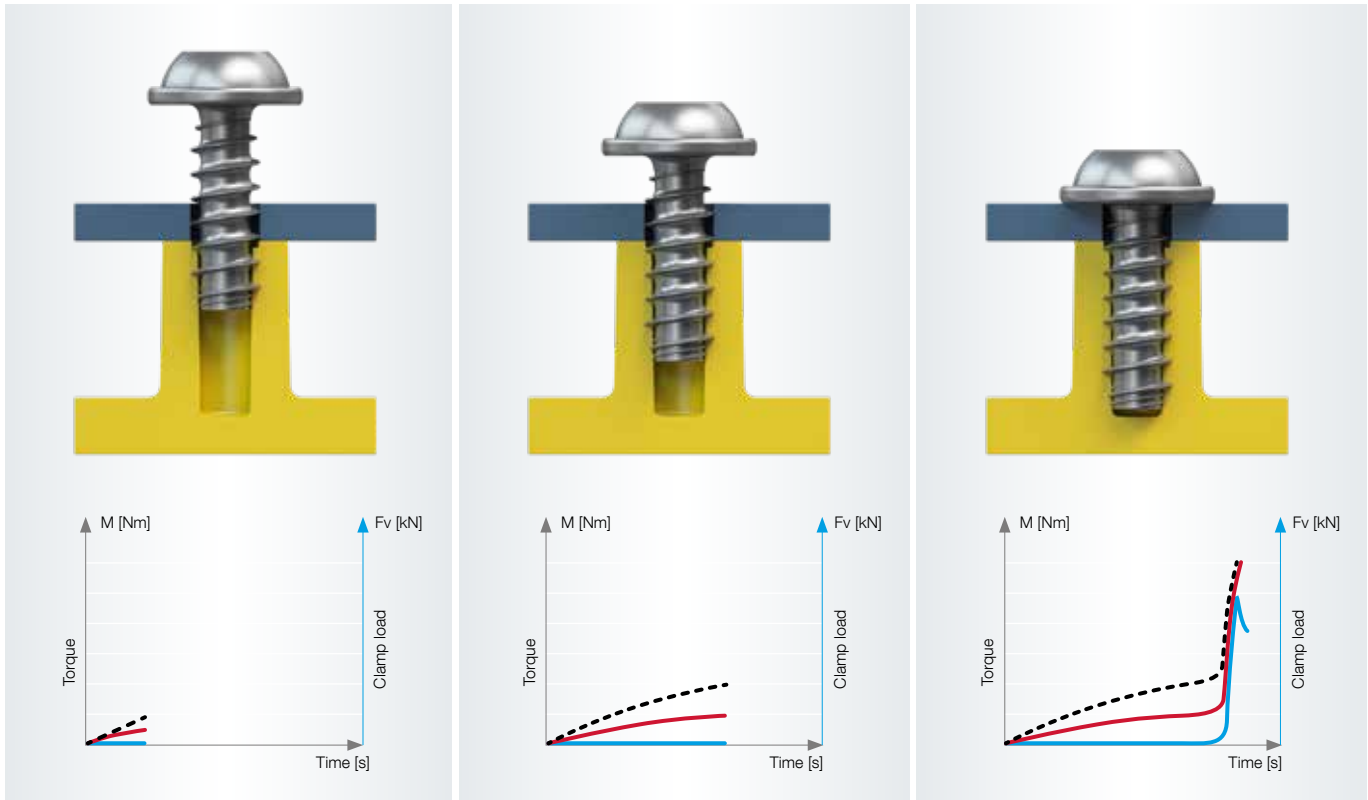

1 Application and forming of the first thread

2 Thread forming

3 Final tightening

- Conventional torque curve in Nm
- Torque EVO PT® in Nm
- Clamp load in kN

The thread forming process

The unique thread forming zone of the EVO PT® allows for an almost constant installation torque over the installation depth.

The thread forming zone forms a thread turn in the female material which is slightly larger than the clearance that the following thread turns require. Thus, the EVO PT® creates a precisely calculated clearance so that the following thread turns can penetrate into the plastic without any appreciable friction. You can recognize this by the flattening installation torque curve with increasing installation depth (picture 1 and 2).

The clearance created through the pre-forming with the forming thread turn has a size which approximately corresponds to the elastic recovery of the used plastic material. This means that the plastic re-attaches to the thread flanks after the screw has been completely inserted (picture 3).



Thread forming zone forms thread turn into the material

Clearance for following thread turns

Elastic recovery of the plastic material

This effect opens up completely new possibilities of component design and extended fields of application, since the complex and uneconomic compensation of different installation depths in the component for varying clamp part thicknesses can be omitted. You benefit from a significant reduction of parts variety and a standardised component design.

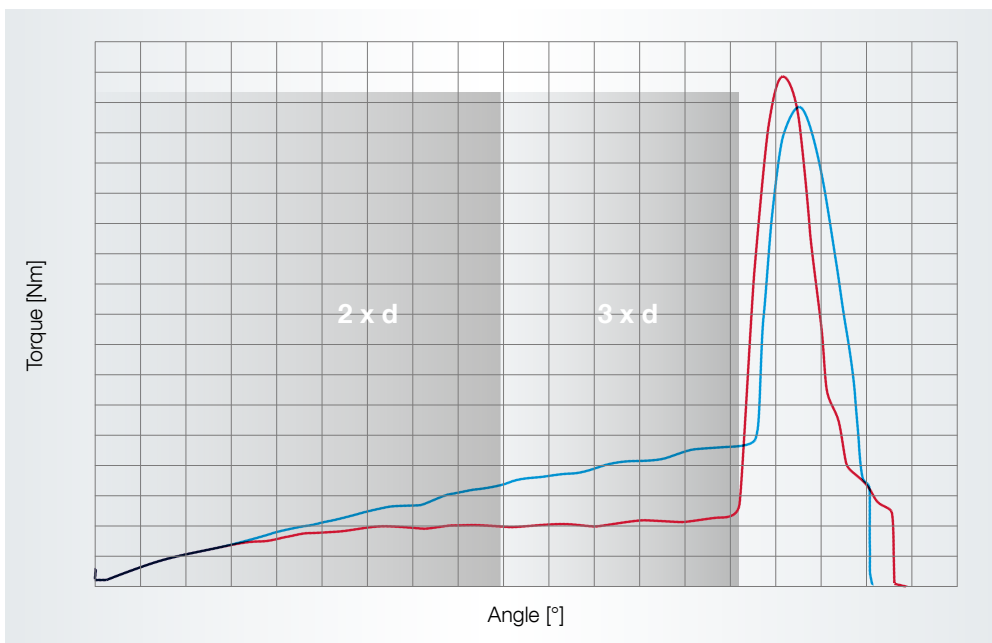

Torque curve of conventional direct fastening into plastic compared to the EVO PT®

— Conventional direct fastening into plastic
 — EVO PT®

Advantages

- Variable installation depth
- Compensation of different clamping part thicknesses
- Reduction of part variety

EJOT EVO PT® – is all about you

Everyone is taken care of

It's part of our role to support your design work even before your customer places the order. Together, we can incorporate the positive benefits of direct fastening into plastic into your assembly application at an early stage. Since at the end of the day, the new EJOT EVO PT® is all about you, a better result for your customer and ultimately, your economic success.

We want you to

- plan and produce in a cost- and time-optimised way
- produce process-reliably and without errors
- enthuse your customers with your quality before and after the order placement
- receive the order
- quickly have your product ready for serial production

As a manufacturer of products and components, you not only have to control your production. Every process in your company has an impact on your overall success. That's why we keep an eye on the requirements of all persons involved in the overall process and provide you with measurable advantages thanks to the EVO PT®.

Advantages for

Design engineers

- Maximum mechanical safety
- Precise performance forecasting
- No thread inserts necessary
- Relieving the time budget

Advantages for

Process engineers

- Maximum plant availability
- Maximum process reliability
- Consolidation of parts
- Error avoidance
- Harmonised assembly concepts

Advantages for

Quality managers

- Reduced effort for sampling, series and inspection
- Low error potential
- Consolidation of parts

Advantages for

Purchasers

- Competitive purchase prices
- Consolidation of quantities
- Reduced complexity
- Low total project costs
- Consolidation of suppliers

EJOT - project supporter and part supplier

You can benefit from the real strengths of the EVO PT® screw when we support your project from concept to completion, achieving the optimal fastening solution for your component - together.

Request end customer

- On-site application engineering by EJOT
- Design recommendation
- Support for component design
- Advice in case of challenging joining tasks

Validation

- Trials in our test laboratory APPLITEC
- Production of prototypes

Series

- On-site support at series run-up
- Series-accompanying support

CAE Services

- EVO CALC®
- CAE services
- FEM simulation

Sampling

- Delivery of series parts

Design recommendation

Simple and universal design recommendation for EVO PT® screws

The recommended counterbore depth is $0.1 \times$ nominal diameter of the screw d_1 . A compensation of different clamping part thicknesses by means of different counterbore depths is eliminated, since the forming thread turn generates a virtually constant forming torque.

Since injection-moulded pre-holes are assumed, they usually have a draft angle of 1° , resulting in an pre-hole diameter of $0.85 \times d_1$, measured at the top of the pre-hole.

If component constraints mean that the design recommendation cannot be implemented in individual cases, the EVO CALC® calculation software offers the opportunity to assess these situations and make recommendations.

For a better measurability, the pre-hole diameter d_b at the top of the pre-hole is given as $0.85 \times d_1$.

- Nominal diameter of the screw in mm: d_1
- Counterbore diameter: $d_E = d_1 \times 1.05$
- Hole diameter: $d_b = 0.85 \times d_1 \pm 0.05 \text{ mm}$
- Installation depth: $t_e = 2 \times d_1$ or deeper
- External boss \varnothing : $d_T = 2 \times d_1$
- Clearance hole \varnothing : $d_h = 1.05 \text{ bis } 1.1 \times d_1$
- Counterbore depth: $t_s = 0.1 \times d_1$
- Hole depth allowance: $t_c = 0.5 \times d_1$

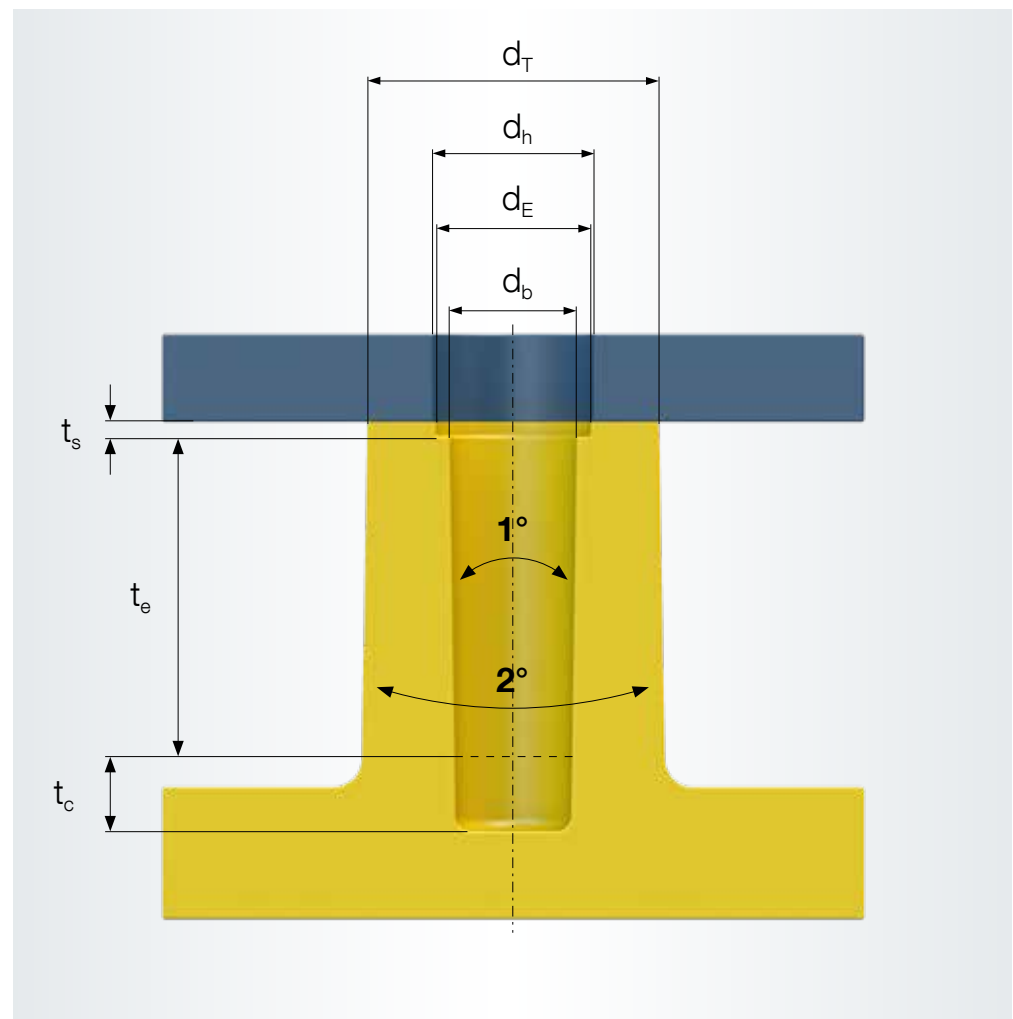

A screw goes digital

Your intelligent planning services

When configuring and using EVO PT® screws, you may benefit from these exclusive services:



Preliminary design of your screw joint with EVO CALC®



The prognosis program EVO CALC® especially developed for this screw enables the fast and precise determination of all values and information concerning the installation of the EVO PT® which are important for your project.

This comprises, for example, the creation of a design recommendation, the calculation of the relevant torques, the determination of different forces such as the clamp load at the tightening torque as well as the presentation of possible failure modes in case of overload. The results provide you with immediate information on whether your assembly group is already optimally designed for your requirements or what has to be done to achieve your optimum.

If you have any further questions, please do not hesitate to contact your application engineer.

Detail taken from the prognosis program EVO CALC®



Advantages

- Prediction of torques and clamp loads
- Early identification of failure risks
- Downsizing suggestion
- Saving of component tests

FEM

Even more planning safety with numeric calculation

The calculation of design and assembly parameters can be ensured quickly and with sufficient accuracy using analytical calculation methods. Often, however, the question arises as to how the clamp load will behave when loaded after the assembly. In the case of direct fastening into plastic, especially the relaxation, which means the time- and temperature-dependent loss of clamp load, must be taken into account.

Conventional analytical mathematical models are simplistic and eventually too imprecise to reliably predict this process. Therefore, EVO CALC® has been equipped with an interface with a numerically calculating FEM system (Finite Element Method). With this program, it is possible to create a temperature profile to be simulated, which means to define the corresponding load case and to pass it to the numeric calculation together with the relevant initial conditions and design parameters.

In conjunction with complex material models, the FEM system calculates the anticipated clamp load curve and eventually the final residual clamp load. Time-consuming and cost-intensive temperature tests can thus be reduced to a minimum.

FEM analysis of the screw joint

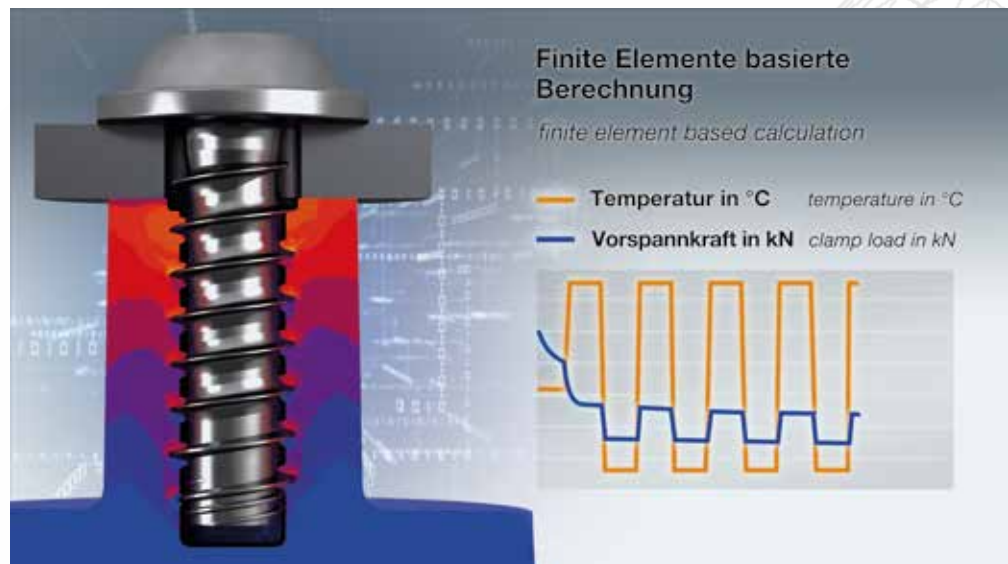

Advantages

- Precise prediction of the relaxation behaviour
- Information on the clamp load retention under operating conditions
- Reduction of time-consuming and cost-intensive temperature tests

CAE

Computer-aided engineering for complete assembly groups

EVO CALC® is aimed at examining the individual fastening points. However, questions as to how different load cases (temperature, operating forces etc.) might affect the entire assembly group also arise frequently. An example of this is the load on the screwed parts due to an internal pressure and the question of which pressure the connection is able to tolerate before it opens up so far that there is no more tightness or even the most heavily loaded fastening point fails.

These and other questions can be answered with the help of our powerful CAE services. On the basis of the calculated results we show possible downsizing potentials and develop precise recommendations for the best possible and stable connection together with you.

With these special engineering services, we bundle all our competencies in the field of direct fastening into plastic. You save precious development time and costs.

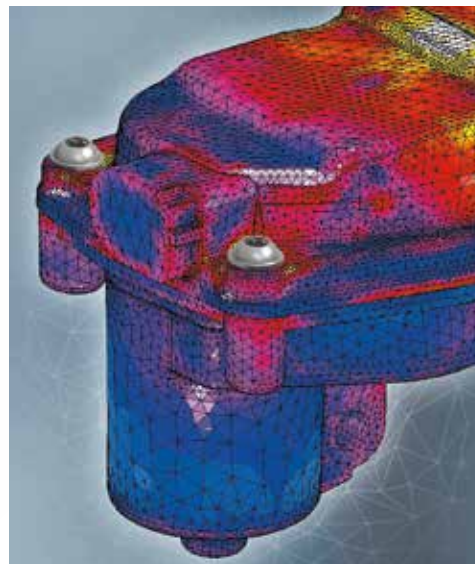
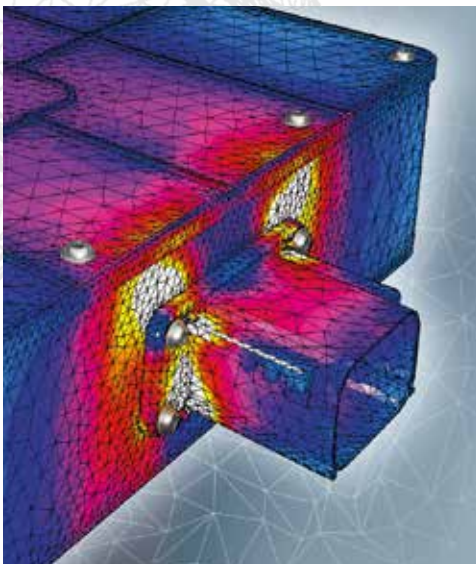

Stress analysis in the component under load

Advantages

- Inspection of multi-screw connections
- Information on the most heavily loaded fastening point
- Simulation under operating load
- Relief of engineering resources

Practically unbeatable

Optimisation approaches with the EVO PT® screw using a case study

The design example shown here is a conventional and professional component design according to standard design guidelines for direct fastening into plastic. The assembly group and its components are analysed with regard to an optimisation of the screw joint. It will be shown if factors such as dimensioning or component diversity can be optimised.

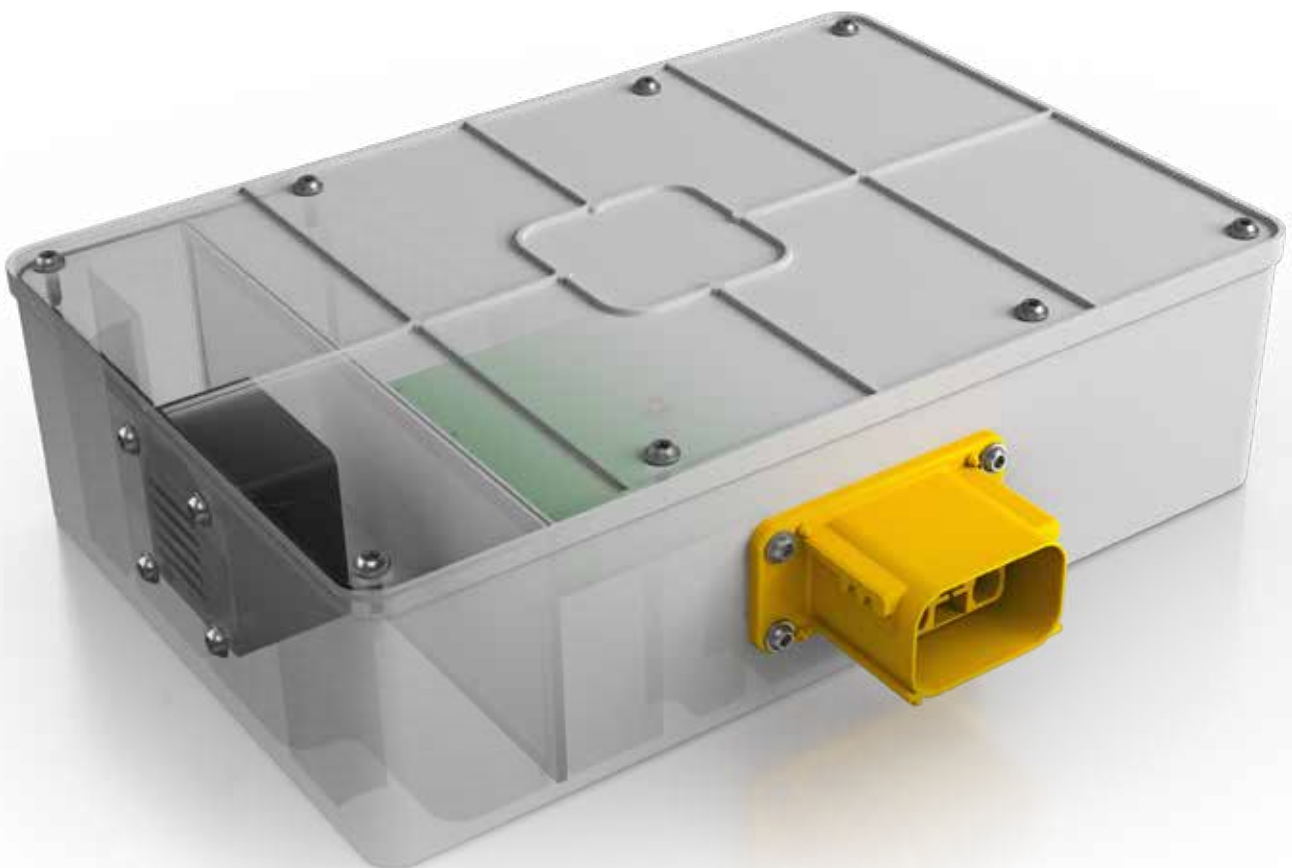

Unfold for the
detailed analysis



Cover

Detailed analysis:

- Validation and determination of forces in screw joints
- Assessment of the exhaustion of downsizing potentials with EVO CALC®, thus a reduction of the screw size is possible
- Saving of expensive and time-consuming component tests

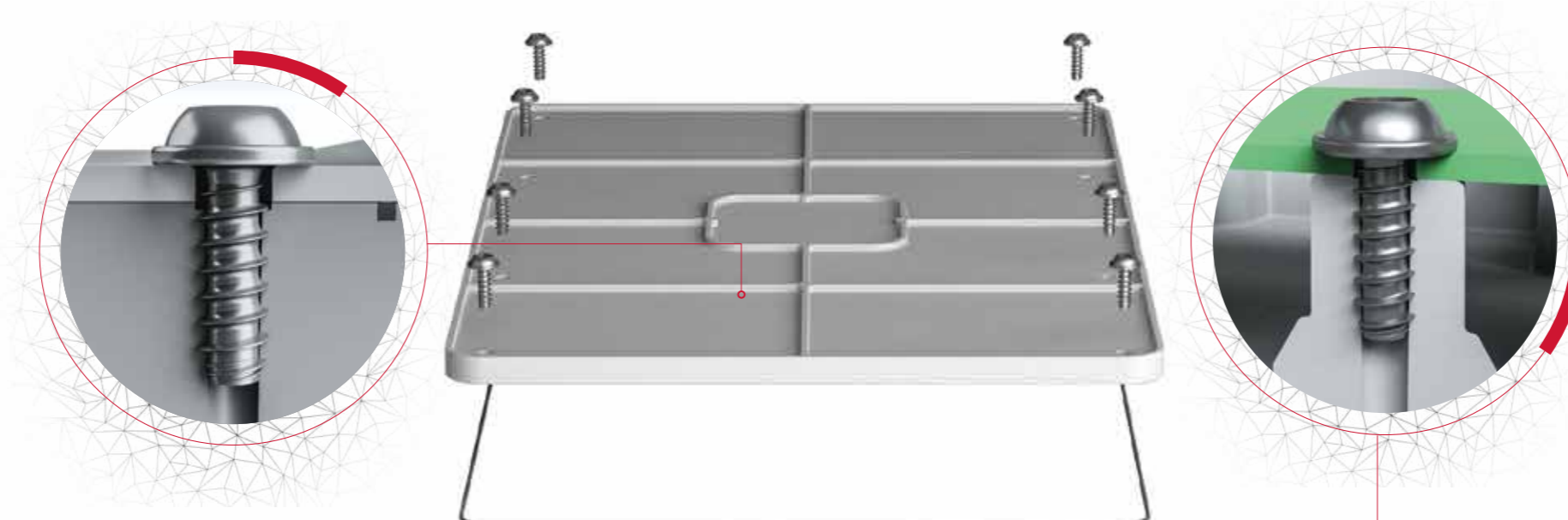

Circuit board

Detailed analysis:

- Longer screw, but same tightening torque M_a with more installation depth
- Recommending a longer screw for standardisation reasons (same tightening torque/same screw) to avoid confusion in the production

Analysis



Fan

Detailed analysis:

- Lead-in thread facilitates the assembly of the screw in the component without counterbore
- Straight application of the screw, the positioning thread takes over a finding function in the pre-hole, which otherwise is ensured by the counterbore
- Usage of catalogue parts without counterbore, no new design necessary
- Reliable joining

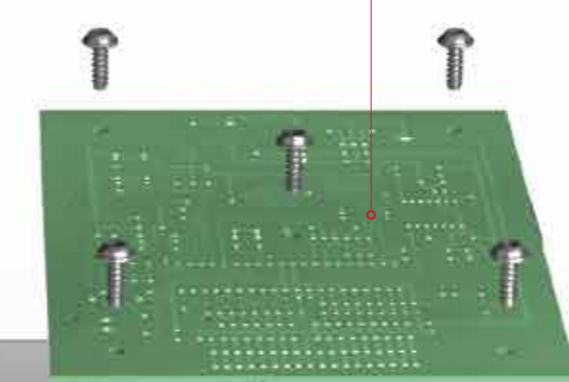

Plug

Detailed analysis:

- Usage of a tube design with significantly reduced counterbore depth
- Increased installation depth is thus available
- Alternatively, the screw length can be reduced
- Usage of the small counterbore depth and possibility to pre-calculate the design with EVO CALC® in order to standardise the design to an EVO PT® screw 40 x 12.

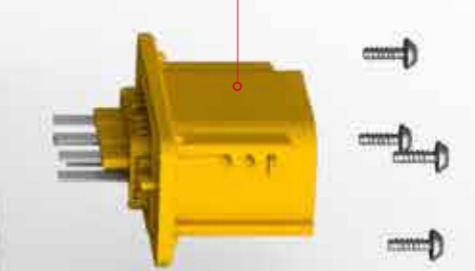

Conclusion

The same tube design is consistently used throughout the whole assembly group. The varying installation depths, resulting from the different clamping part thicknesses, are no problem thanks to the functionality of the forming thread turn. This reduces the effort for the designer and the process engineer:

One tube design, one tightening torque, one screw.

The EVO PT® effect

Instead of four different screw variants, one EVO PT® screw can be used for all positions in the design example. The calculated savings potential of 20 % only refers to the individual item „screw“.

There are additional cost savings through optimised production, logistics, warehousing and quality processes.

Bill of materials for the example: 100,000 housings per year

Conventional component design

Screws	Fastening to	Clamping part	Quantity	Demand per year	Delivery
5.0 x 14	Housing	Cover	8	800,000	80,000
4.0 x 12	Fan	Housing	4	400,000	40,000
4.0 x 15	Housing	Plug	4	400,000	40,000
3.5 x 10	Housing	Circuit board	5	500,000	50,000

The consequent application of the EVO PT® features

- Lead-in thread
- Forming thread turn
- EVO CALC®

leads to error prevention and consolidation of required quantities thanks to the usage of one screw for different installation depths. This results in uniform assembly conditions.

20%

Optimised design with EVO PT® screws

Screws	Fastening to	Clamping part	Quantity	Demand per year	Delivery
40 x 12	Housing	Cover	21	2,100,000	210,000
	Fan	Housing			
	Housing	Plug			
	Housing	Circuit board			

Standard versions with tolerances

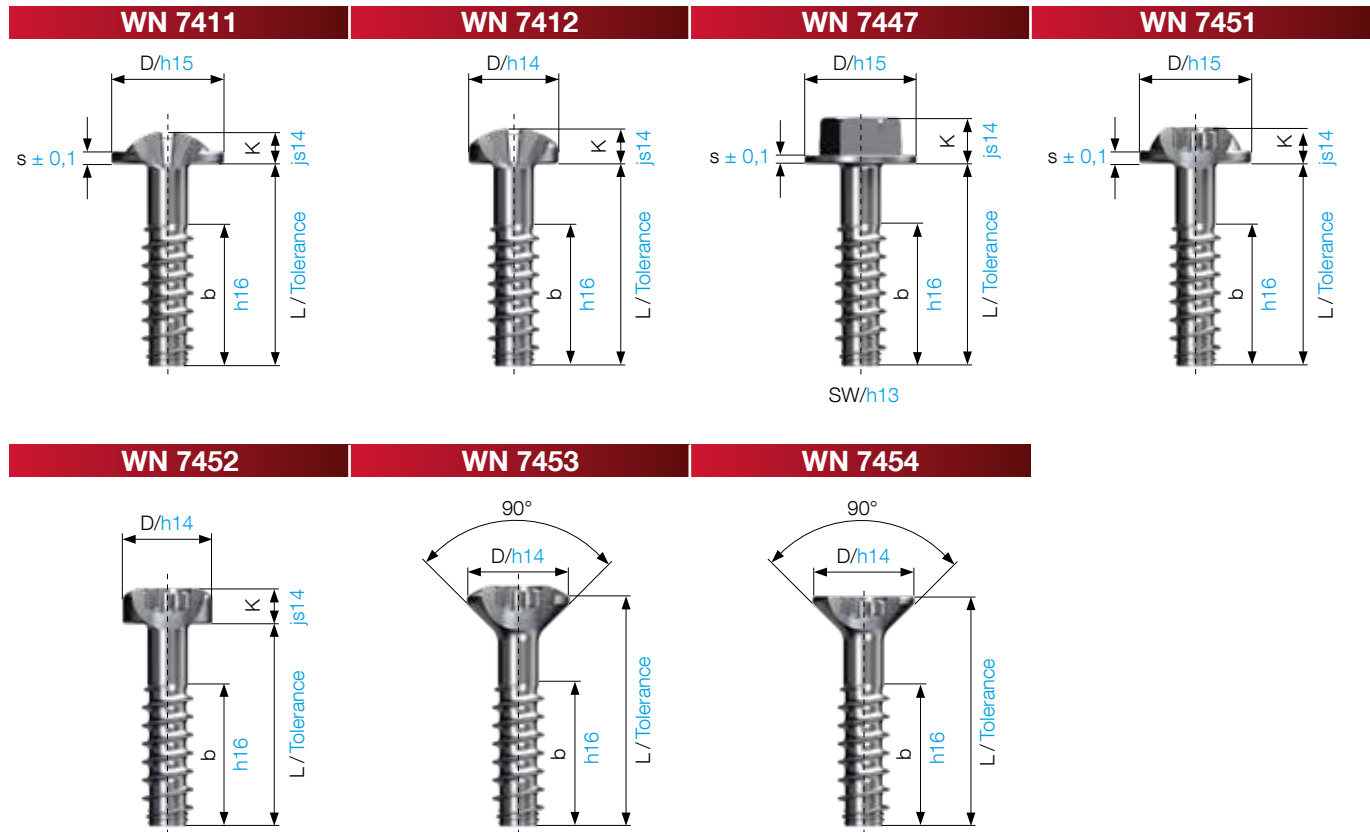

	Tolerance ranges							
	up to 3	more than 3 up to 6	more than 6 up to 10	more than 10 up to 18	more than 18 up to 30	more than 30 up to 50	more than 50 up to 80	more than 80 up to 120
h 13	0	0	0	0				
	- 0.14	- 0.18	- 0.22	- 0.27				
h 14	0	0	0	0	0			
	- 0.25	- 0.30	- 0.36	- 0.43	- 0.52			
h 15	0	0	0	0	0			
	- 0.40	- 0.48	- 0.58	- 0.70	- 0.84			
h 16	0	0	0	0	0	0	0	0
	- 0.60	- 0.75	- 0.90	- 1.10	- 1.30	- 1.60	- 1.90	- 2.20
js 14	± 0.12	± 0.15	± 0.18					
Tolerance for L at (d₁ ≤ 5)		± 0.38	± 0.45	± 0.45	± 0.55	± 0.65	± 0.80	± 0.80
Tolerance for L at (d₁ > 5)				± 0.55	± 0.65	± 0.80	± 0.80	± 0.80

All dimensions are valid before coating!

* rounded up

All cross and TORX® drives are also available as combi drives with additional slot. Special drives upon request.

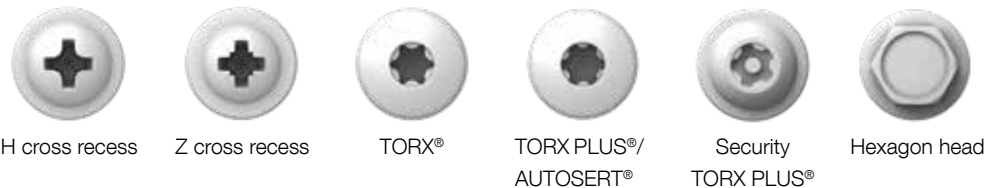



Order example

Description of an EVO PT® screw with pan head and TORX PLUS® drive, nominal Ø 4.0 mm and a length L = 20 mm
EVO PT® screw WN 7452 40 x 20

EVO PT® screws	Reference dimension		30	35	40	45	50	60	70	80	90	100	
	External thread Ø nom.	d ₁	3.00	3.50	4.00	4.50	5.00	6.00	7.00	8.00	9.00	10.00	
	Tolerance Ø		+ 0.06	+ 0.08	+ 0.08	+ 0.10	+ 0.10	+ 0.12	+ 0.14	+ 0.16	+ 0.18	+ 0.20	
	Thread core Ø	d ₂	2.13	2.53	2.84	3.24	3.61	4.40	5.03	5.83	6.50	7.29	
	Tolerance Ø		± 0.06	± 0.08	± 0.08	± 0.08	± 0.10	± 0.10	± 0.12	± 0.12	± 0.12	± 0.12	
Thread pitch	P	1.08	1.26	1.44	1.62	1.80	2.16	2.52	2.88	3.24	3.60		

	WN 7411		30	35	40	45	50	60	70	80	90	100
	Head Ø	D		6.50	7.50	9.00	10.00	11.00	13.50	15.50		
Head height	K		2.10	2.40	2.50	2.50	3.20	4.00	4.60			
Washer thickness	s		0.80	0.90	1.00	1.00	1.20	1.40	1.60			
Radius	R _{max}		0.50	0.50	0.60	0.60	0.70	0.80	0.90			
Cross size H/Z			1	2	2	2	2	3	3			

	WN 7412		30	35	40	45	50	60	70	80	90	100
	Head Ø	D		5.30	6.10	7.00	7.50	8.80	10.50	12.30		
Head height	K		2.30	2.70	3.10	3.20	3.50	4.20	5.10			
Radius	R _{max}		0.50	0.50	0.60	0.60	0.70	0.80	0.90			
Cross size H/Z			1	2	2	2	2	3	3			

	WN 7447		30	35	40	45	50	60	70	80	90	100
	Head Ø	D		6.50		9.00		11.00	13.50		18.00	
Head height	K		2.80		3.50		4.50	5.20		7.00		
Washer thickness	s		0.07		0.90		0.90	1.10		1.30		
Radius	R _{max}		0.50		0.60		0.80	0.80		1.00		
Width across flats	A/F		5.00		5.50		7.00	8.00		10.00		

	WN 7451		30	35	40	45	50	60	70	80	90	100
	Head Ø	D		6.50	7.50	9.00	10.00	11.00	13.50	15.50	18.00	
Head height	K		2.30	2.70	3.10	3.20	3.50	4.20	4.90	5.60		
Washer thickness	s		0.80	0.90	1.00	1.10	1.20	1.40	1.60	1.80		
Radius	R _{max}		0.50	0.50	0.60	0.60	0.70	0.80	0.90	1.00		
TORX PLUS®/AUTOSERT®			10IP	15IP	20IP	20IP	25IP	30IP	30IP	40IP		
Installation depth t	min		1.00	1.10	1.40	1.40	1.50	1.90	2.30	2.60		
	max		1.30	1.50	1.80	1.80	1.90	2.40	2.90	3.20		

	WN 7452		30	35	40	45	50	60	70	80	90	100
	Head Ø	D		5.30	6.10	7.00	7.50	8.80	10.50	12.30	14.10	
Head height	K		2.30	2.70	3.10	3.20	3.50	4.20	4.90	5.60		6.60
Radius	R _{max}		0.50	0.50	0.60	0.60	0.70	0.80	0.90	1.00		1.10
TORX PLUS®/AUTOSERT®			10IP	15IP	20IP	20IP	25IP	30IP	30IP	40IP		50IP
Installation depth t	min		1.00	1.10	1.40	1.40	1.50	1.90	2.30	2.60		3.00
	max		1.30	1.50	1.80	1.80	1.90	2.40	2.90	3.20		3.70

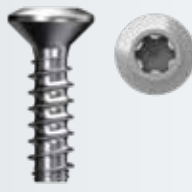
	WN 7453		30	35	40	45	50	60	70	80	90	100
	Head Ø	D		6.00	7.00	8.00	9.00	10.00	12.00	14.00	16.00	
Cyl. head height	c _{max}		0.55	0.65	0.70	0.70	0.75	0.85	0.90	0.95		1.10
Storm washer height	≈f		0.70	0.80	1.00	1.00	1.20	1.20	1.30	1.40		1.60
Radius	R _{max}		1.20	1.40	1.60	1.80	2.00	2.40	2.60	3.20		4.50
TORX PLUS®/AUTOSERT®			10IP	15IP	20IP	20IP	25IP	30IP	30IP	40IP		50IP
Installation depth t	min		1.00	1.10	1.40	1.40	1.50	1.90	2.30	2.60		3.00
	max		1.30	1.50	1.80	1.80	1.90	2.40	2.90	3.20		3.70

	WN 7454		30	35	40	45	50	60	70	80	90	100
	Head Ø	D		6.00	7.00	8.00	9.00	10.00	12.00	14.00	16.00	
Cyl. head height	c _{max}		0.55	0.65	0.70	0.70	0.75	0.85	0.90	0.95		1.10
Radius	R _{max}		1.20	1.40	1.60	1.80	2.00	2.40	2.60	3.20		4.50
TORX PLUS®/AUTOSERT®			10IP	15IP	20IP	20IP	25IP	30IP	30IP	40IP		50IP
Installation depth t	min		0.75	0.95	1.10	1.25	1.25	1.50	2.30	2.40		3.00
	max		1.00	1.30	1.45	1.70	1.65	2.00	2.90	2.90		3.70

All dimensions in mm.

Manufacturing range of screws with supported head*

EVO PT®	30	35	40	45	50	60	70	80	90	100
Ø d ₁ [mm]	3.0	3.5	4.0	4.5	5.0	6.0	7.0	8.0	9.0	10.0
Screw length [L]	Partial thread lengths [mm]									
6	5									
7	6	6								
8	7	7	7							
9	8	8	8	8						
10	9	9	9	9	9					
11	9	10	10	10	10					
12	9	10	10	11	11	11				
13	12	10	12	11	12	12				
14	12	10	12	13	12	13	12			
15	12	14	12	13	12	14	13			
16	12	14	12	13	15	14	14	14		
17	12	14	16	13	15	14	14	15		
18	12	14	16	13	15	14	16	16	16	
19	12	14	16	18	15	18	16	17	17	
20	12	14	16	18	15	18	16	18	18	18
21	12	14	16	18	20	18	16	18	19	19
22	12	14	16	18	20	18	16	18	20	20
23	12	14	16	18	20	18	21	18	21	21
24	12	14	16	18	20	18	21	18	21	22
25	12	14	16	18	20	24	21	18	21	23
26	12	14	16	18	20	24	21	24	21	23
28	12	14	16	18	20	24	21	24	21	23
30	12	14	16	18	20	24	28	24	28	23
32		14	16	18	20	24	28	24	28	30
35		14	16	18	20	24	28	32	28	30
36			16	18	20	24	28	32	28	30
40			16	18	20	24	28	32	36	30
45				18	20	24	28	32	36	40
50					20	24	28	32	36	40
60						24	28	32	36	40
70							28	32	36	40
80								32	36	40
90									36	40
100										40

The given values are to be understood as manufacturing ranges (no stock articles).
 The grey fields mark the next partial thread step.
 Partial thread lengths for countersunk heads upon request.

To check your first off-tool parts, we recommend control assemblies in our APPLITEC test laboratory.

* acc. to WN 7411, 7412, 7447, 7451, 7452

Coatings & materials

Materials for the EVO PT® made of metal:

- Through-hardened steel according to EJOT WN 7461 part 2
- Austenitic steel according to EJOT WN 7461 part 4
- Aluminium 6056

Further materials and coatings are available upon request.

Chrome VI-free coatings for the steel screw:

- Zinc-plated, blue passivated
- Zinc-plated, thick-film passivated (with or without sealing)
- Zinc flake coatings (with or without sealing/black top coat)
- ZnFe, ZnNi, transparent passivated (with or without sealing/top coat)
- ZnFe, ZnNi, black passivated (with or without sealing/top coat)

EJOCLEAN®

With the EJOCLEAN® program, EJOT offers individual solutions to use „clean“ fasteners in the assembly in order to achieve the best possible purity on component surfaces.



zinc-plated,
blue passivated



zinc-plated,
thick-film-passivated
+ sealing



Zinc flake
coatings (with or
without sealing/
black top coat)



ZnFe, ZnNi,
transparent passivated
(with or without
sealing/top coat)



ZnFe, ZnNi,
black passivated
(with or without
sealing/top coat)

Drawing and special parts upon request

Examples





Service and support

Always perfect advice and assistance

The EJOT concept of total quality goes far beyond outstanding product features. You can expect best performance and service from us. Our goal is always to benefit the customer through added value service. We want you to be successful.



Engineering advice

A major consideration of today's product manufacture is the basic need to be cost competitive. The cost structure of the manufactured product is significantly influenced by the design engineering. To assist our customers in this process, EJOT offers support during the design stage by comprehensive application engineering services. These services provide accurate information on product performance and result in design recommendations that can be used safely on the product line.



Consequent application engineering

The daily work with our customers and their application queries greatly influences our understanding of fastening technology and opens up possibilities for innovation. This way we consequently improve our products to meet customer demands and needs. In addition to highly qualified engineers and application engineering consultants, our application laboratory, the EJOT APPLITEC, is at your disposal. In this laboratory components are checked thoroughly and the customer has the possibility to have an individual examination of his application done. Following the analysis, he receives professional proposals concerning the best possible fastening solution.



Online service

Besides the possibility to have components tested in our laboratory, we offer our customers several prognosis programs to pre-design direct assemblies in thermoplastics and light metals. Practical examples prove that considerable cost savings are already possible during the development phase by using these programs. After the required registration on the EJOT homepage these calculation tools as well as downloads of CAD data and product information are also available online.



Logistics and data exchange

It is our aim to keep procurement and warehousing costs as low as possible by simultaneously offering product availability and quality. With regards to simplified procurement processes, EJOT offers a variety of cost reducing procedures and services.

The continued analysis of our customers demands and advanced logistics procedures lead to high availability of our products.



EJOT sales structure

In addition to the international EJOT companies, a growing number of licensees and members of the Global Fastener Alliance all over the world ensure the global availability of products and local support.

For further information concerning the EJOT license management, please contact Mrs. Jasmin Hegener, Global License Management (phone +49 2752 109-1488, e-mail: jhegener@ejot.com).



EJOT SE & Co. KG

Market Unit Industry
Im Herrengarten 1
57319 Bad Berleburg, Germany

Phone: +49 2751 529-0
Fax: +49 2751 529-559
E-mail: industrie@ejot.com
Internet: www.ejot.com/industry

Legal notice

Published by:
EJOT SE & Co. KG
Market Unit Industry
D-57319 Bad Berleburg

© by EJOT SE & Co. KG
EJOT®, EVO PT®, EVO CALC® and EJOCLEAN®
are registered trademarks of
EJOT SE & Co. KG.
TORX®, TORX PLUS® and AUTOSERT® are registered
trademarks of Acument Intellectual Properties LLC.

Picture credits: iStock, Shutterstock

Subject to technical changes.