

# ECORIV® Niete

DE

EN

## Produktübersicht

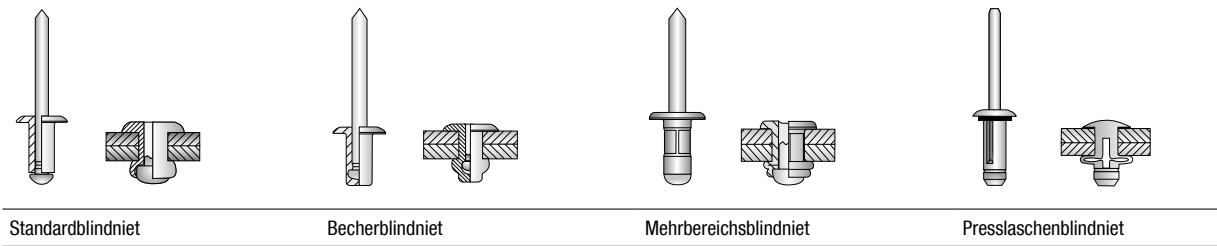

### Standardblindniet

Typ [mm]	d <sub>0</sub> [mm]
3,0xL	3,1
3,2xL	3,3
4,0xL	4,1
4,8xL	4,9
5,0xL	5,1

### Becherblindniet

Typ [mm]	d <sub>0</sub> [mm]
4,8xL	4,9

### Mehrbereichsblindniet

Typ [mm]	d <sub>0</sub> [mm]
4,0xL	4,1
4,8xL	4,9

### Presslaschenblindniet

Typ [mm]	d <sub>0</sub> [mm]
5,2xL	5,3

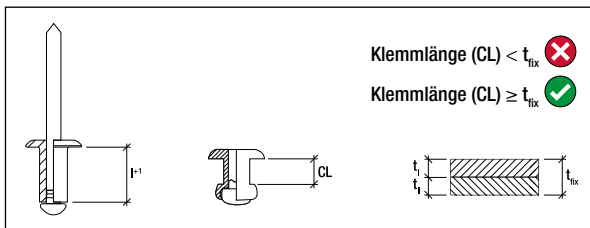

## Hinweise



ETA-22/0641



Fachregeln des Metallleichtbaus (IFBS)



Augenschutz benutzen



Bis zur Montage trocken lagern

## Montageablauf

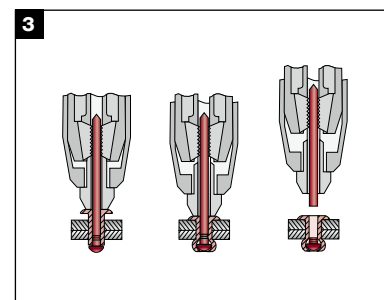
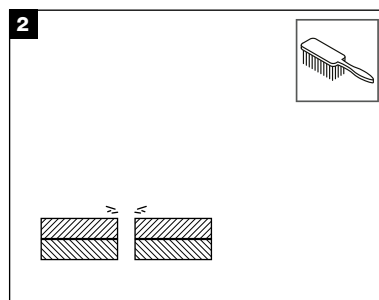
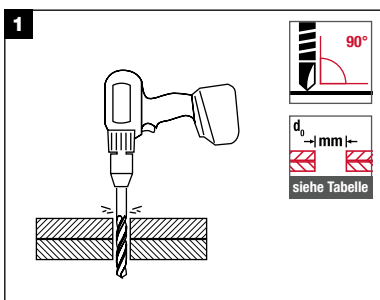

# ECORIV® Rivets

## Product overview

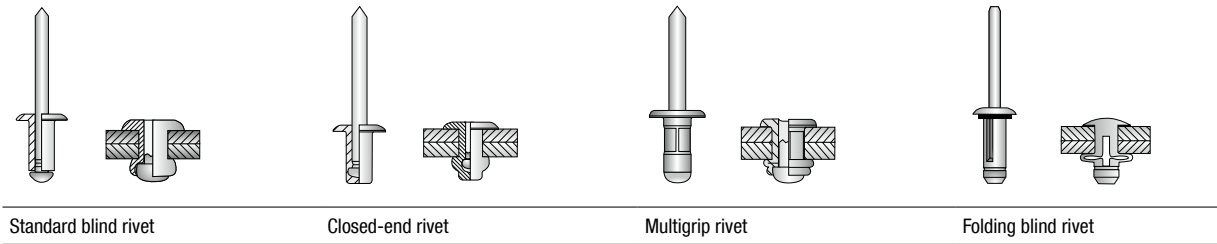

Standard blind rivet	
Type [mm]	d <sub>0</sub> [mm]
3.0xL	3.1
3.2xL	3.3
4.0xL	4.1
4.8xL	4.9
5.0xL	5.1

Closed-end rivet	
Type [mm]	d <sub>0</sub> [mm]
4.8xL	4.9

Multigrip rivet	
Type [mm]	d <sub>0</sub> [mm]
4.0xL	4.1
4.8xL	4.9

Folding blind rivet	
Type [mm]	d <sub>0</sub> [mm]
5.2xL	5.3

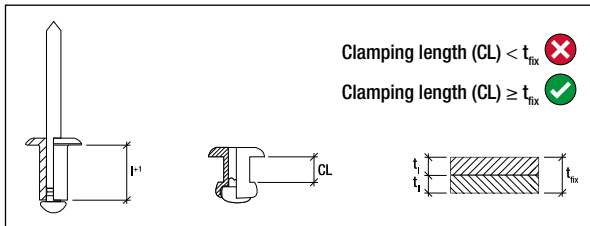

## Notes



ETA-22/0641



Rules of lightweight metal construction (IFBS)



Eye protection must be worn



Store dry until installation

## Assembly process

